

MARIO NEW F-3

Art.-Nr.

200314

602
447
306
mm

1/4
Z0



100 min



PZ 2



≤ 0,5 kg



3m







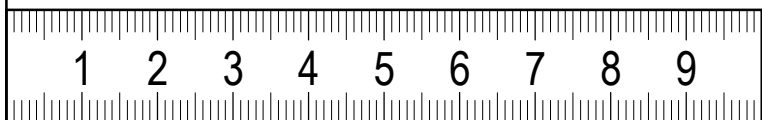
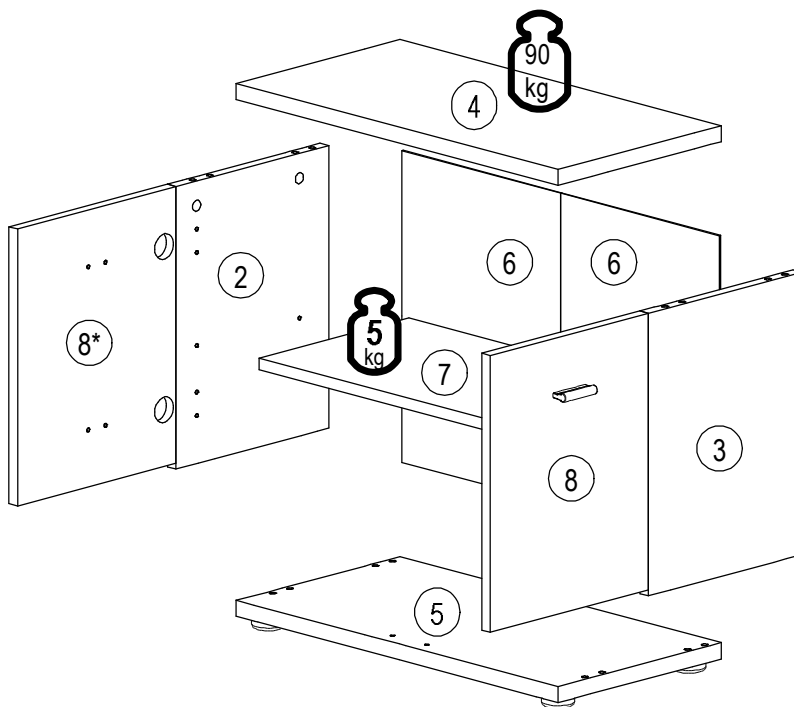
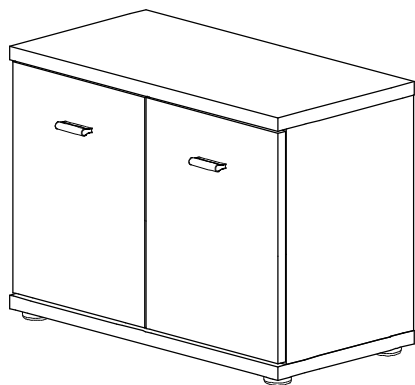

4

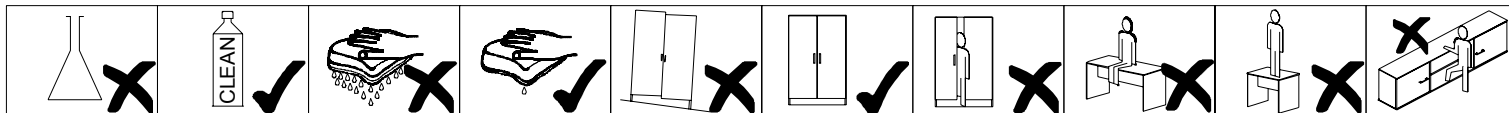
| ID | ID | Icon | Icon | Icon |
|-------|----|-------------|------|------|
| 14047 | 2 | 388*286*16 | 1x | 1/1 |
| 14048 | 3 | 388*286*16 | 1x | 1/1 |
| 14006 | 4 | 602*306*22 | 1x | 1/1 |
| 14007 | 5 | 602*306*22 | 1x | 1/1 |
| 14049 | 6 | 428*297*2,5 | 2x | 1/1 |
| 14009 | 7 | 568*280*16 | 1x | 1/1 |
| 14050 | 8 | 380*296*16 | 2x | 1/1 |



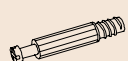

| | | | | | | | | | |
|------------------------------|-----------------------------|---------------------------|----------------------------|------------------|-----------------------------|------------------|---------------------------|------------------|------------------|
| 21102,00 Ø1,2x20 A 25x | 22244,01 Ø3,5*16 B 2x | 22213,00 Ø4x70 C 1x | 27000,00 Ø8*30 D 8x | 70013,01 E 4x | 70021,01 F 4x | 70021,01 G 4x | 22300,00 Ø7x50 H 4x | 35102,00 J 2x | 35101,01 K 4x |
| 22250,00 Ø4x25 L 4x | 24103,00 Ø8 M 1x | 22430,00 Ø4x25 N 4x | 30080,00 Ø44x15 P 4x | Q 4x | 22243,00 Ø3,5x15 R 8x | 31103,00 S 1x | 36002,07 T 4x | 36002,07 U 4x | 32008,00 V 2x |

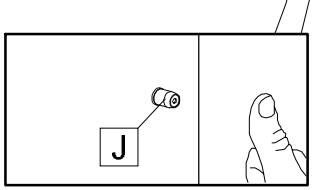
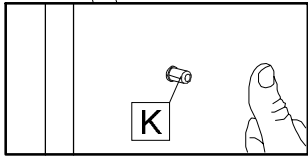
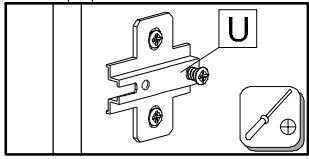
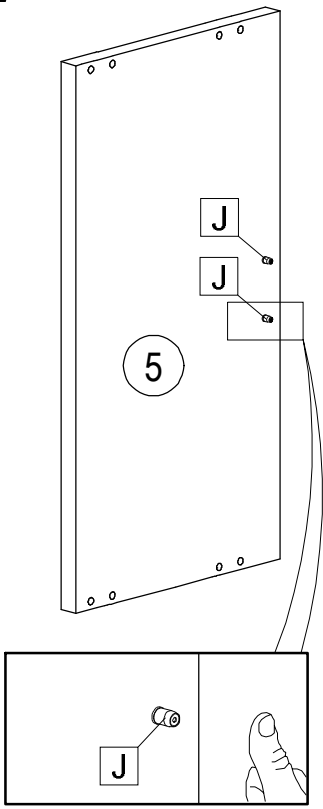
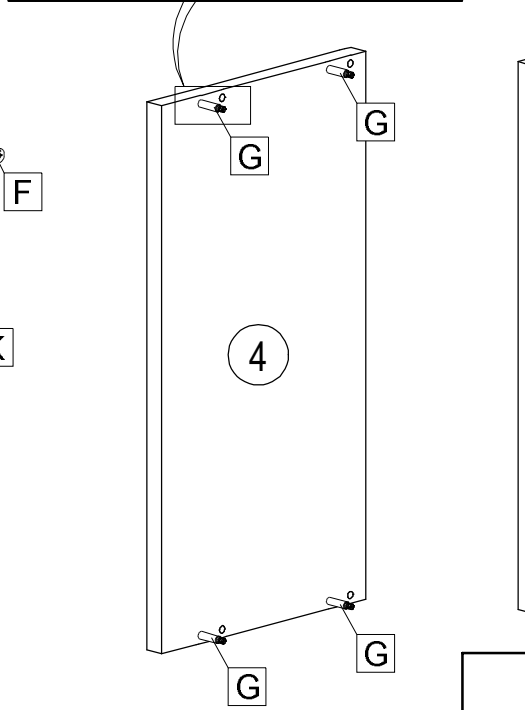
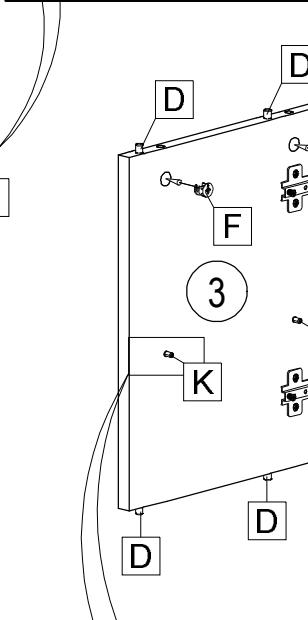
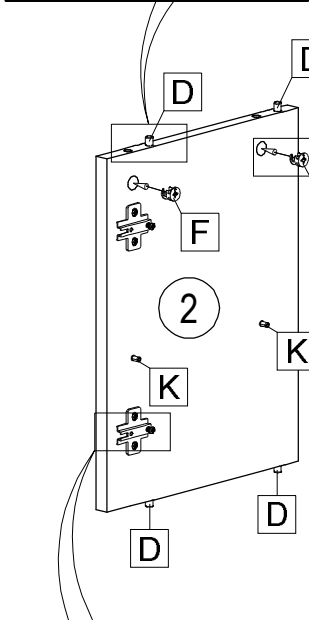
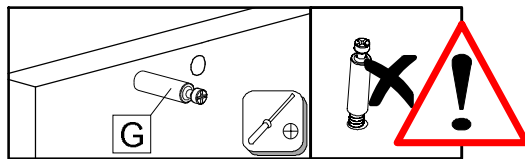
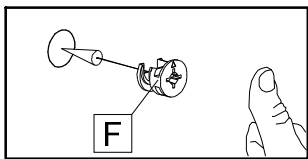
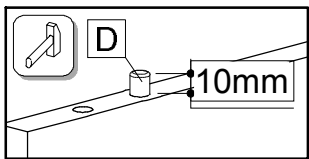

| | | | | | |
|--|---|---|---|---|---|
|  |  |  |  |  |  |
| D 8x | F 4x | G 4x | J 2x | K 4x | U 4x |

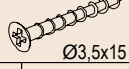

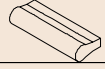

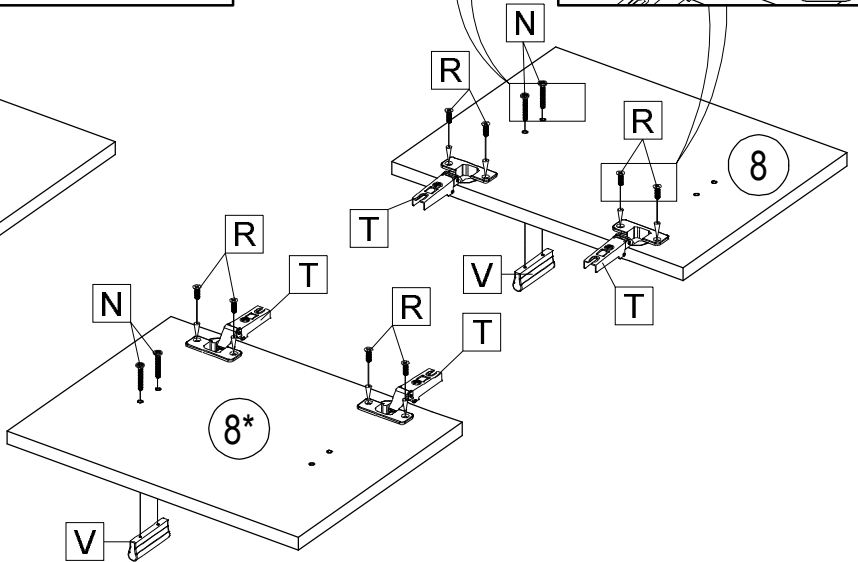
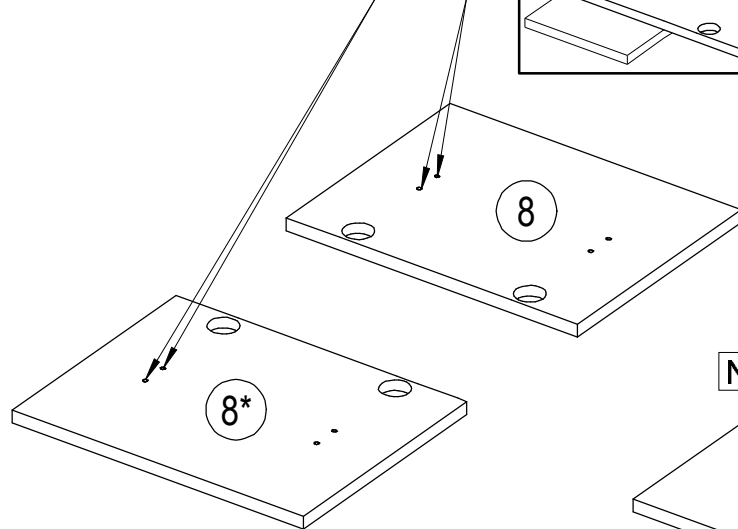
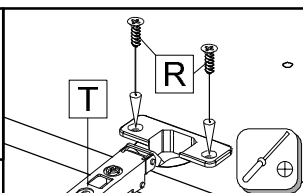
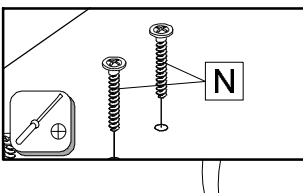
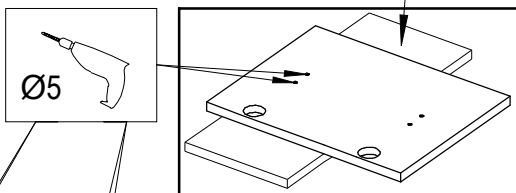
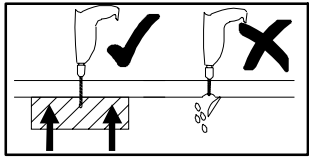
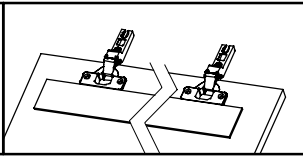
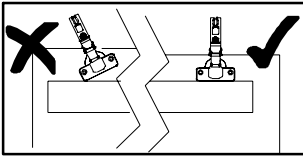
| | | | |
|--|---|---|---|
|  |  |  |  |
| N 4x | R 8x | T 4x | V 2x |

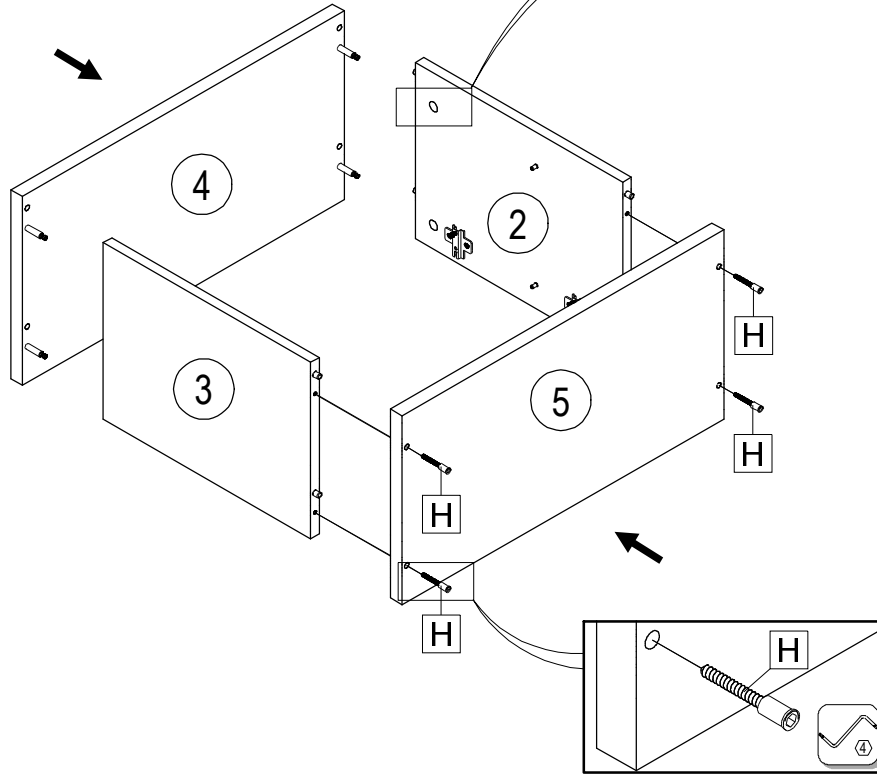
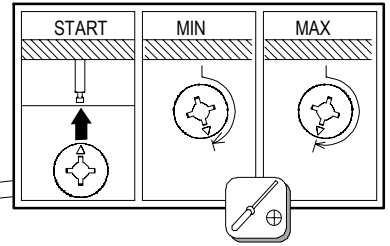

| | |
|--|-------|
|  | Ø7x50 |
| H | 4x |

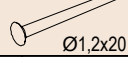

| | | | | | |
|--|---------|---|-------|---|--------|
|  | Ø1,2x20 |  | Ø4x25 |  | Ø44x15 |
| A | 25x | L | 4x | P | 4x |

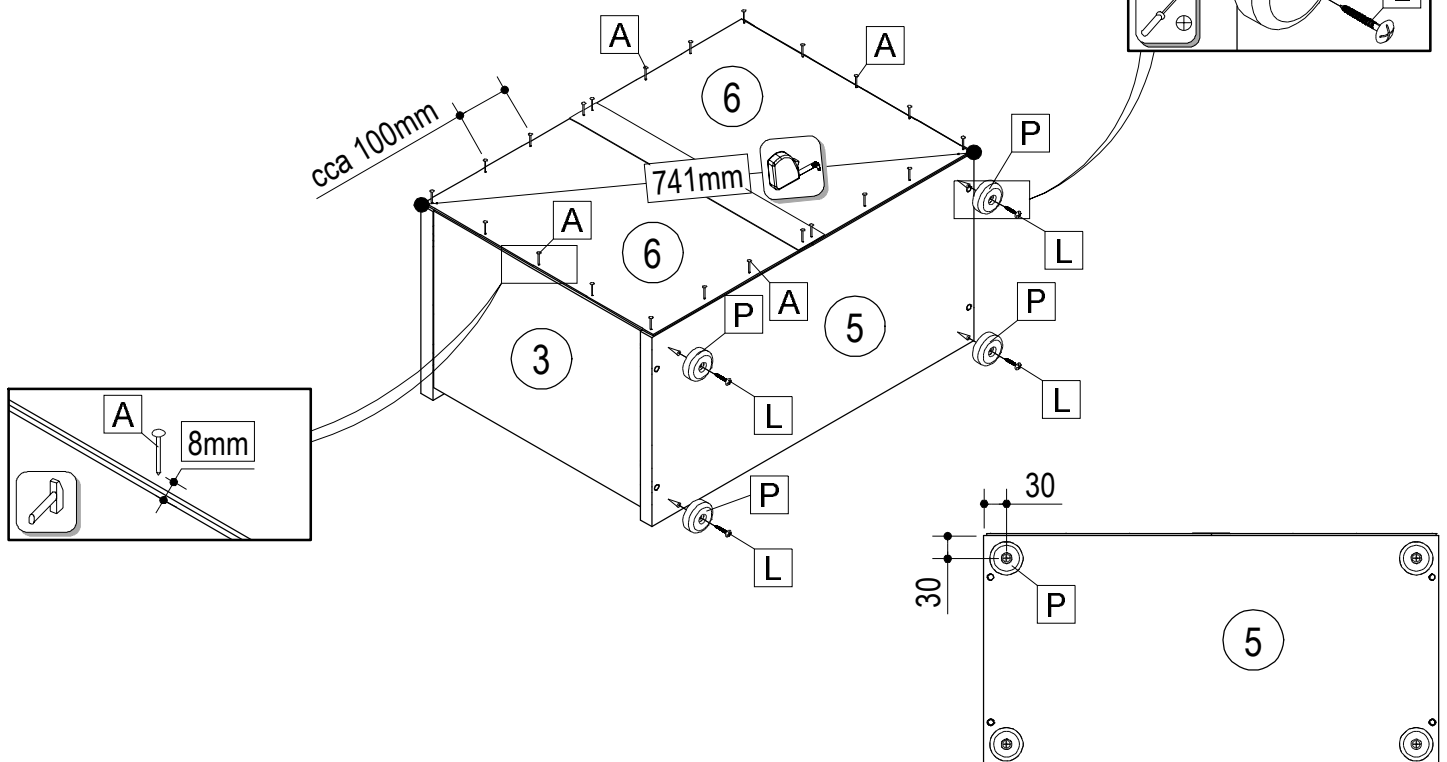
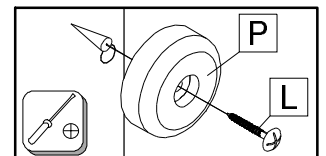

| | |
|------|------|
| | |
| B 2x | C 1x |
| | |
| M 1x | S 1x |

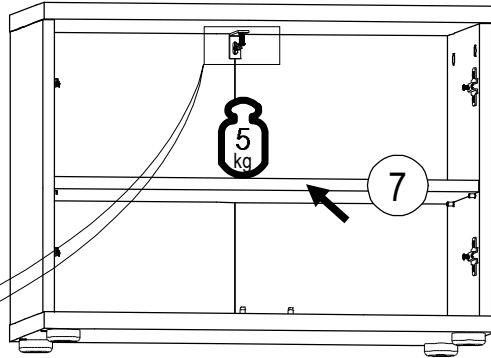
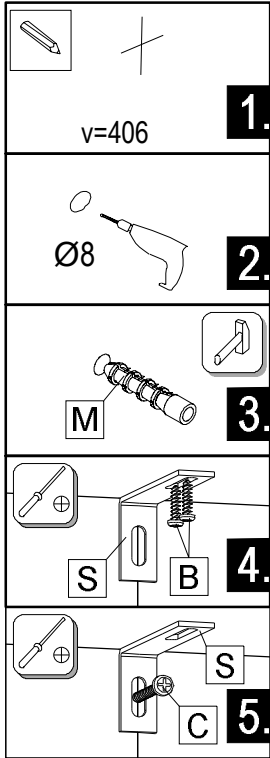
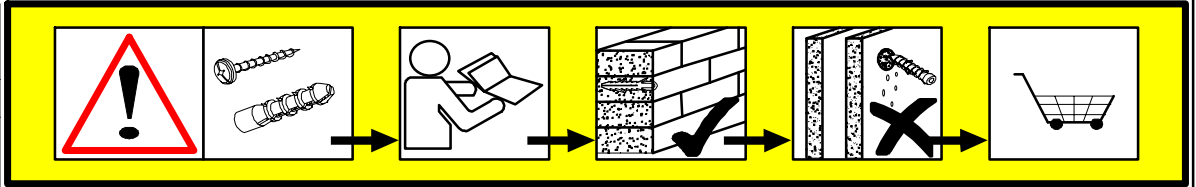

| | |
|----|--|
| DE | Achtung! Die Wandbeschaffenheit ist vor der Montage unbedingt zu prüfen. Die beigelegten Universaldübel sind ausschließlich nur zur Verwendung für festes Mauerwerk wie Beton/Ziegel. Die Mauerdübel dürfen nicht bei Mauerwerk wie Hohlraumziegel, Leichtbausteinen, Gipskartonplatte oder anderer Rahmenbauweise verwendet werden. Bei diesen Mauerwerken sind gegebenenfalls Spezialdübel zu verwenden! Diese sind in einem Fachgeschäft (Baumarkt) erhältlich. Bei Nichteinhaltung wird seitens Produzenten/Händler und Importeur keine Haftung übernommen. |
| SK | Upozornenie! Pevnosť steny sa musí pred montážou bezpodmienečne skontrolovať. Univerzálne hmoždenky, ktoré sú obsiahnuté v balení, používajte jedine pre pevné murivo ako je betón/tehla. Hmoždenky sa nesmú používať v prípade ľahkého staveného muriva, dutina tehla, u sádrokartónových dosiek alebo iných konštrukcií rámu. U týchto murív je nutné použiť špeciálne hmoždenky! Tieto je možné dostať v špeciálnych predajniach so stavebným materiálom (stavebniny). Pri nedodržení pokynov nepreberajú výrobcovia/predajci a dodávateľa zodpovednosť za vzniknuté škody. |
| HU | Vigyázat! Szerelés előtt a falfelületet feltétlenül vizsgálja meg. A mellékelt univerzális tiplik kizárólag stabil falazathoz használható mint például beton/tégla. A fal tiplik nem használható könnyű építőkövekhez, üreg tégla, gipszkarton lapokhoz vagy más favázás építményekhez. Ezekhez a falfelületekhez csak speciális tiplik használhatóak, melyek szaküzletekben (barkácsruházakban) beszerezhetőek. Fentiek figyelmen kívül hagyása esetén a gyártó/kereskedő vagy forgalmazó nem vállal felelősséget. |
| CZ | Upozornění! Před montáží je nutné zkontrolovat stav stěny. Příložené univerzální hmoždinky jsou určeny pouze k použití pro pevné zdivo jako beton/cihly. Hmoždinky do zdi se nesmí používat u dutinová cihla, zdiva jako pórovitý stavební kámen, sádrokartónová deska nebo jiný měkký materiál. U těchto zdív jsou nutné použít speciální hmoždinky! Jsou k dostání v speciálních prodejnách se stavebním materiálem. Při nedodržení těchto pokynů výrobce/prodejece a dovozce neručí za způsobené škody. |

| | |
|------|------|
| | |
| E 4x | Q 4x |

